FINAL REPORT

DE-4208 RESORT

**REMOTE SERVICE OF
REHABILITATION TECHNOLOGY**

May 1998 – December 2000

Project co-ordinator:
fortec - Vienna University of Technology

**TELEMATICS APPLICATIONS PROGRAMME
(Sector "Disabled and Elderly")**

Authors:
Paul Panek, Wolfgang L. Zagler



Date: 25/05/2001
Version number: 1.20

Project Consortium:**Contracting Partners:**

- Institut für Industrielle Elektronik und Materialwissenschaften, TU Wien, AT (C1-fortec)
- Austrian Research Centers, AT(C2-ARCS)
- University of Dundee – Micro Centre, UK (C4-DUMC)
- Institute for Rehabilitation Research, NL (C5-IRV)

Associated Partners:

- Elisabethinum Axams Förderzentrum in Tirol, AT (A1-ELI)
- RehaKomm Jacobi GbR, DE (A2-RECO)

Subcontractors:

- Franciscusoord, Rehabilitationszentrum für Kinder, Valkenburg (S1-FO)
- Capability Scotland, UK (S4a-USCS)
- Tayside Orthopaedic and Rehabilitation Technology Centre, UK (S4b-TORT)

Contact address for the Project:

Wolfgang L. Zagler, Paul Panek
fortec - Research Group on Rehabilitation Technology
Institute of Industrial Electronics and Material Science
Vienna University of Technology
Favoritenstrasse 11/366-1B
A-1040 Vienna
Austria
Telephone: +43-1-58801-76611
Fax: +43-1-58801-36697
E-mail: resort-fortec@fortec.tuwien.ac.at
WWW http://www.fortec.tuwien.ac.at/resort

The Project DE-4208 RESORT (Remote Service of Rehabilitation Technology) has been supported by the European Commission under the auspices of the TELEMATICS APPLICATIONS Programme.

**Further information on the TELEMATICS APPLICATIONS Programme:**

You can obtain more information on the projects of the TELEMATICS APPLICATIONS Programme from:

IST Information Desk
European Commission
Directorate-General Information Society
Office BU 31 1/19
Rue de la Loi, 200
B-1049 Brussels
Belgium
E-mail: ist@cec.eu.int
Tel: +32-2-296 8596
Fax: +32-2-296 8388
http://www.cordis.lu/ist

Copyright: DE-4208 RESORT Consortium, 2001

This document is electronically available on: <http://www.fortec.tuwien.ac.at/resort>

Content:**Part I Executive Summary-** Edited Final Report**Part II Final Report-** Full Text**History of this Document:**

date	version	changes
09/03/2001	v1.00	original version
21/05/2001:	v1.10	merged into one file, correction of typos
25/05/2001	v1.20	several corrections of typos etc.

DE-4208 RESORT

Remote Service of Rehabilitation Technology

The RESORT project has developed a prototype system for remotely maintaining and supporting disabled users and their care persons. It was successfully evaluated in real life tests, an open protocol for making 3rd party RT systems RESORTable has been proposed.

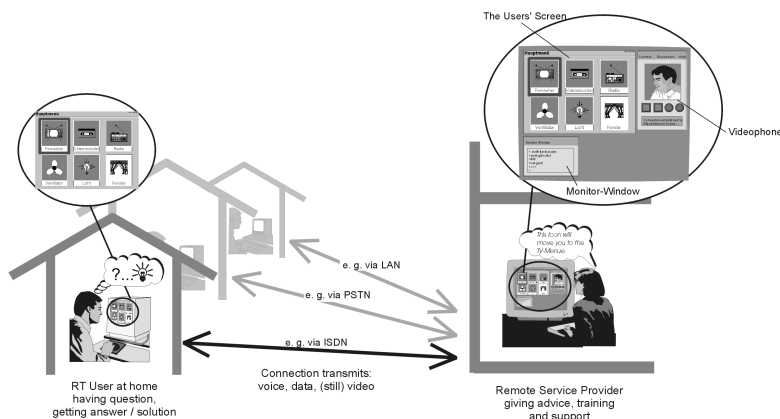

Setting the Scene

Depending on the available bandwidth of the telecommunications connection between the RT user and the service provider a speech, video and data link can be established by the RESORT prototype system. Via this connection the service provider has not only the possibility to communicate with the user in a way which meets all the specific needs of the disabled or elderly client and his/her care person but also gains access to the user's RESORTable RT applications for executing

most of the necessary service, updating and troubleshooting tasks.

Approach

Rehabilitation Technology (RT) equipment is more and more based on standard PC hardware and operation systems. This, on the one hand, makes it feasible to apply existing remote operation and service strategies which already exist for commercial use. On the other hand economic solutions for multimedia telecommunication (voice, video, data) are available.

RESORT is using and has further developed these instruments for offering remote service provision for disabled and elderly people which will improve their independence and quality of life by using Assistive Technology.

Results and Achievements

The consortium released 4 revisions of the RESORT Prototype System which had been developed and improved in iterative cycles. The Advanced RESORT Prototype System offers three different modes of operation:

(a) In the **telephone mode** RESORT provides hands free communication between user and service provider. If the bandwidth is large enough an additional video link can be established.

(b) In the **student-teacher mode** an additional data-link is established. The service provider will load exactly the same RT application as the user is running. The two applications - at the user's site and at the provider's site - will be synchronised via the data link.

(c) In the **tele-service-mode** the service provider will have the possibility to down- and upload files from and to the user's PC, modify configurations and test the changes he/she has made.

The user interface of the RESORT controller can be tailored according to the needs of the users. Although the full functionality is always available, the degree of complexity of functions and information shown to the individual user can be varied within a wide range.

In order to ensure a high level of flexibility several internal interfaces were

introduced. The outcome is a highly modular system which allows to exchange specific parts without the need of adapting other parts. This increases the independence from 3rd party products for audio, video, application sharing, desktop sharing, etc.

Additionally to the RESORT prototype software the **RESORT protocol** has been developed which allows other manufacturers of Assistive Technology systems to adopt the RESORT protocol for their products in order to strengthen their position in the RT market.

Conclusions and Plans for the Future

As framework for further co-operation after completion of the EU funded project currently the **Resort Interest Group (RIG)** is being set up. Main objective of the RIG is to administer exploitation rights, to co-ordinate the exploitation efforts and make arrangements concerning revenues from exploiting the results of the RESORT project.

An interim RESORT SDK has been compiled

mid of February 2001 due to demand from market. It has been sent to one of the interested parties (a German SME) in order to let them integrate basic RESORTability into an already available RT application.

Contact Details

Project Name:

RESORT - Remote Service of Rehabilitation Technology

Research Area:

Tele-Help, Tele-Training, Tele-Support, service provision

Timescale:

01.05.98 - 31.12.2000

Budget:

Overall cost: 1,260.267 ECU
European Commission contribution: 870.000 ECU

Keywords:

tele training, service provision, tele support, maintenance

Project Participants:

fortec, Vienna Univ. of Technology	(AT)
Austrian Research Centres	(AT)
Applied Computing, Univ. of Dundee	(UK)
iRv - Rehab. Research	(NL)

Elisabethinum Axams	(AT)
RehaKomm, Langenau	(DE)
Tayside Clinic Dundee	(UK)
Upper Springland, Perth	(UK)
Franciscusoord, Valkenburg	(NL)

Project Coordinator:

Wolfgang L. Zagler
Tel: +43 1 58801 76611
Fax: +43 1 58801 36697
E-mail: resort-fortec@fortec.tuwien.ac.at
Project URL: <http://www.fortec.tuwien.ac.at/resort>

<blank page>

Content of Final Report (full text)

1. SETTING THE SCENE	2
USERS ADDRESSED	2
BACKGROUND	2
THE CHALLENGE – A VERSATILE REMOTE SUPPORT SYSTEM DEDICATED FOR THE RT MARKET	3
RESORT CONSORTIUM	3
2. APPROACH	5
OBJECTIVES	5
APPROACH	5
IDENTIFICATION OF USER NEEDS	6
DEVELOPMENT OF FUNCTIONAL SPECIFICATIONS	6
DEMONSTRATOR BUILDING AND VERIFICATION	7
DEMONSTRATION PHASE	8
DEPLOYMENT PHASE	8
EVALUATION AND VALIDATION	8
INVOLVEMENT OF USERS	8
EVALUATION CRITERIA	9
REVIEWING	9
COLLABORATION	10
DISSEMINATION	10
3. RESULTS AND ACHIEVEMENTS	11
CONCEPT AND SPECIFICATION OF RESORT	11
SOFTWARE PROTOTYPES ACHIEVED	11
IMPLEMENTATION AND REDESIGN BASED ON USER INVOLVEMENT	11
MAIN FUNCTIONS OF RESORT PROTOTYPE SYSTEM	12
TECHNOLOGIES AND COMPONENTS	13
SOFTWARE, HARDWARE AND NETWORK REQUIREMENTS	14
SCALEABLE USER-INTERFACE	15
COMPLIANT WITH EXISTING STANDARDS	16
PROPOSED RESORT STANDARD: REMOTE CONTROL INTERFACE v3.21	17
INTEGRATION OF REMOTE CONTROL INTERFACE (RCI) INTO AN RT SYSTEM	18
USAGE OF TRANSPARENT DATA AND MESSAGING CHANNEL	18
INTERFACE-DLL FOR 3 RD PARTY RT SYSTEMS	19
PRELIMINARY RESORT SDK	20
RESULTS AND ACHIEVEMENTS IN WORKSHOPS AND REAL LIFE TESTS	20
RESORT SERVICES	21
RESORT EXPLOITATION	22
4. CONCLUSIONS AND FUTURE PLANS	24
POST PROJECT CO-OPERATION – THE RESORT INTEREST GROUP (RIG)	24
PRESENTATIONS TO AND SUPPORT OF INTERESTED PARTIES	24
CONCLUSION	25
5. CONTACT DETAILS	26

1. Setting the Scene

The RESORT project has introduced up-to-date multimedia telematic into Rehabilitation Technology (RT) equipment by using IT (Information Technology). Starting in May 1998 the project was completed in December 2000. The RESORT project concentrated on PC based equipment like environmental control systems, devices for Alternative and Augmentative Communication or teaching and training software. Depending on the available bandwidth of the telecommunications connection between the RT user and the service provider a speech, video and data link can be established by the RESORT prototype system. Via this connection the service provider has not only the possibility to communicate with the user in a way which meets all the specific needs of the disabled or elderly client and his/her care person but also gains access to the user's RESORTable RT applications for executing most of the necessary service, updating and troubleshooting tasks. In this way RESORT contributes not only to the overall objectives of the Telematics Application Programme (TAP) by developing new and adequate multimedia communication channels between customers and service providers but also completely conforms with the demands described for the Sector "Disabled and Elderly (DE)".

Users addressed

The users addressed by this project cover a wide spectrum from disabled children over disabled adults up to disabled elderly persons, including severe motor impaired persons, cognitive impaired persons, speech and language impaired persons and persons with multiple impairments. On the one hand - all persons using IT-based RT applications including their carers and facilitators, trainers, teachers and therapists and - on the other hand - the suppliers of those RT products benefit from the outcomes of the RESORT project which are described in this report.

Background

An increasing number of disabled people are using RT systems, helping them to live more independent and self-determined lives. In many cases the care persons (teachers, therapists, family members, ...) are key persons in this process. Often a lack of experience in using and configuring RT systems causes a corresponding lack of adaptation and often the total abandonment of Rehabilitation Technology. Generally the actual use of RT systems is much lower than the need. Currently professional support is a complicated and expensive process due to high travel efforts.

The crucial point for user satisfaction often not only is the price for purchasing the equipment but to an even greater extent the costs of personal adaptation and continuous service and updating according to changing user needs. After having installed an RT (Rehabilitation Technology) system the process of tailoring the system to the user's needs and wants has to start. Installation of the RT system is not the end but actually the starting point of an on-going process of service delivery. Step by step the system will be changed to meet the user's needs as close as possible. We can state and emphasise that providing an RT system to a user is much more than delivering a device, connect it to the mains and switch it on. There is the need for tailoring the system to the actual needs of the disabled user, there also is the need for training the user and the care givers (family members, professionals) in the use of the equipment, there also is the need of coaching all of them when they are walking their first steps in using the equipment and there is the need for supporting them in all technical, pedagogic and therapeutic issues concerning the RT system and all the areas affected by the introduction of the RT system. Disabled users and care persons will benefit in these situations significantly by the remote service provided to them by the RESORT prototype system.

The Challenge – A versatile Remote Support System dedicated for the RT market

The RESORT project developed a PC based system that provides online support for the care person. Whenever a problem arises the care person can establish a multimedia link to a RESORT service centre (RSC) and ask questions, get oral explanation and support, can demonstrate what might not function correctly or can learn by watching the RSC solving problems on the remote PC via the data link. Within the RESORT project two already existing RT systems STEP BY STEP, a PC-based learning system for motor or learning disabled children, and AUTONOMY, a combined environment control and AAC system for severely disabled persons, have been used to verify and demonstrate the benefits of the RESORT concept.

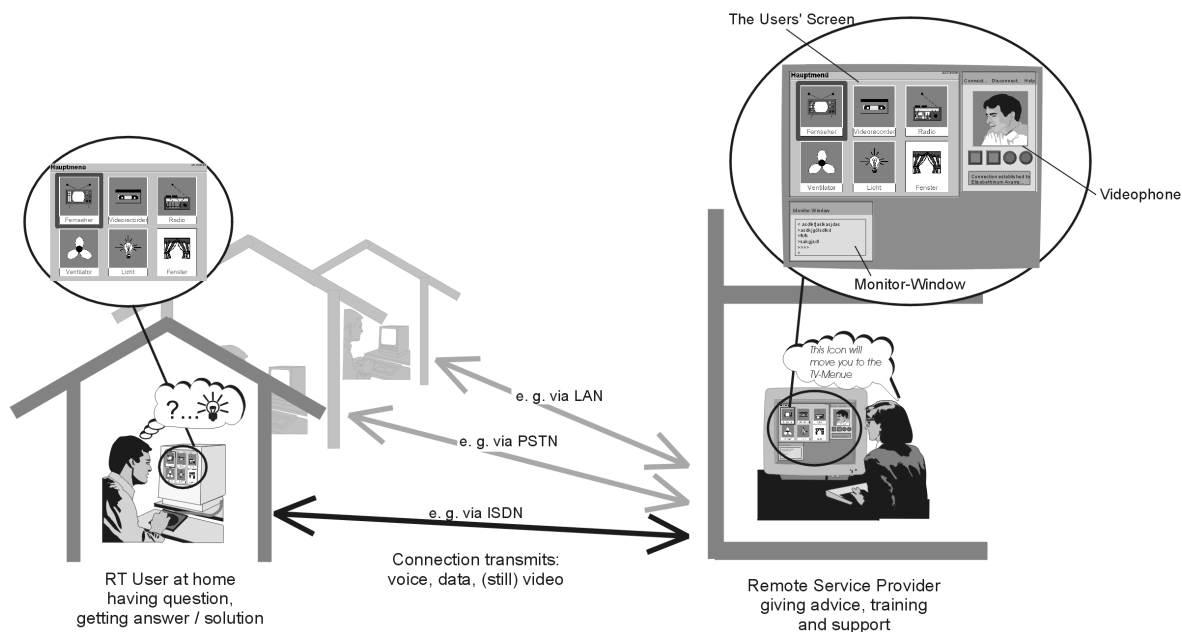

Fig.1: RESORT concept for remote service provision for PC based RT systems. RESORT Service Centre (right side) being connected to RESORT clients which might be localised at private homes, institutional care, schools, support centres,...

Whenever support is needed, the user activates his/her RESORT software which automatically will establish the necessary link to receive multimedia telematic help and support from the RESORT service provider. During the service session the service provider is able to talk with the user in a hands-free telephone conversation while their two PCs are connected in a student/teacher mode. In other words, all activities of the disabled or elderly client and all RT applications related contents of his/her screen are displayed on the service provider’s PC (RESORT Service Centre Workstation). So the service provider can monitor the client’s actions and give appropriate advice. Vice versa the service provider can demonstrate and teach the proper use of the RT system at the client’s home by remote controlling all of its functions. The service provider can also read and write files from and to the client’s PC. By this means the personal relation between user and service provider will be fostered.

Resort Consortium

The RESORT consortium includes partners from four European countries: Austria, Germany, The Netherlands and the United Kingdom. In all of the mentioned countries, a national user group is served by one of the partners, in most cases based on previous co-operation between the partners. Four contracting partners are forming the core of the consortium which is equally balanced between two universities and two industrial partners. It brings together the particular skills necessary for the proposed project in an ideal combination.

C1-fortec is specialised in multimodal user-interfaces for environmental control and AAC-systems and has brought in several years of practical experience in software supporting motor and multiple impaired persons. forttec was responsible for overall co-ordination and administration and for the implementation and redesign work packages. Special areas of responsibilities: Interfaces to audio and video subsystems (H.323), to application sharing subsystem (T.120), specification of Remote-Control Interface (RCI), implementation of Resort Interface DLL, native test beds, Java/Native interfaces for Resort Interface DLL and H.323/T.120 subsystems, RESORTability of RT-system "Autonomy".

C2-ARCS has developed the teaching and training system "*Step by Step*". Besides the skills in rehabilitation technology it brings in the infrastructure of a large industrial research organisation (538 employees) which also is used to technology transfer and commercial exploitation of results. ARCS was responsible for the work packages: Market Survey, System Specification and Exploitation. Special areas of responsibilities: Java test beds, Dialup Module, RESORTability of RT-system "Step by Step".

C4-DUMC is one of the world's leading research institutes investigating the application of computer systems for the disabled. DUMC contributes their knowledge in user interface design and their manifold IT infrastructure. DUMC conducted the work package User Needs Analyses. Special areas of responsibilities: RESORT Controller at Client, RESORT Controller at Service Centre including User Interface and file transfer.

C5-IRV is specialised in research, development and knowledge transfer on rehabilitation and handicaps. iRv co-ordinated work packages verification and demonstration. Special areas of responsibilities: Databases for Client and Service Centre including access functions for controller, RESORT DB-Editor, Installer for RESORT system.

Each of the **A-partners (A1-ELI, A2-RECO)** looks back to many years of experience in serving disabled or elderly persons in different aspects. Together with the **subcontractors** of forttec (**S1-FO**) and **DUMC (S4a-USCS, S4b-TORT)** they have been able to cover the entire user spectrum from schoolchildren to elderly disabled persons and can maintain all the necessary contacts for ensuring permanent user involvement.

In early 2001, all C-Partners, A-Partners and the Subcontractors have established the RESORT Interest Group (RIG) in order to ensure post project co-operation after completion of the EU-funded RESORT project (December 2000).

Please note, that original Contractor **C3-ALH** and Associated Contractor **A3-SRL/Dynamed** had to terminate their participation on April 30, 1999 (one year after project commencement) due to insurmountable internal financial problems. The new contractor **C5-IRV** has continued the work of defaulting contractor C3-ALH from May 1, 1999 onwards. New subcontractor **S1-FO** has carried out the validation tasks originally planned for A3-SRL/Dynamed.

2. Approach

Objectives

The main objective of the RESORT Project was the development, verification, demonstration and dissemination of a multimedia telematic communication strategy to be used between users of IT-based Rehabilitation Technology products and their service providers.

The benefit for the users which is provided by the RESORT prototype system is an easy to use and quick accessible channel by which assistance and service can be obtained. Manufacturers and service providers will profit from reduced service costs due to less travelling by establishing new organisational structures based on RESORT.

Within the project the necessary software packages for establishing the most suitable telematic link between users and service providers have been developed, tested and demonstrated. The link is serving different purposes like:

- Communication between user and service provider in the most comfortable (hands free telephony plus video-telephony wherever possible) and appropriate (taking into account most of the different communication disorders which RT-users can suffer from) way.
- Reading log-files and other relevant data from the user's PC for remote troubleshooting and diagnosis (therapeutic and technological).
- Remote training (re-training) the user by simultaneous telecommunication with the user and demonstration of system usage by remote controlling the user's equipment.
- Remote troubleshooting and upgrading the user's equipment by operating the PCs of the service provider and the user in a teacher/student (pilot/co-pilot) setting.
- The person-to-person level where the service provider and the user are able to communicate mostly by phone or videophone but also by text messages (e.g. if the user is deaf or non-vocal) or by symbol language (e.g. with an aphasic client).
- The computer-to-computer level which synchronises input and output of both PCs. In other words, user and service provider can view the same screen contents (and discuss them) and the service provider can remotely operate the user's input channels.

Approach

Rehabilitation Technology (RT) equipment is more and more based on standard PC hardware and operation systems. This, on the one hand, makes it feasible to apply existing remote operation and service strategies which already exist for commercial use. On the other hand economic solutions for multimedia telecommunication (voice, video, data) are available. RESORT is using and has further developed these instruments for offering remote service provision for disabled and elderly people which will improve their independence and quality of life by using Assistive Technology (AT). The strategic approach of the RESORT project is based on the following steps according to the 5 phase model:

Identification of User Needs

A study of the user needs has been carried out containing 37 in-depth interviews based on detailed questionnaires. Having analysed the responses in the questionnaires, the consortium drew the following conclusions.

1. The distinction between local and remote carers is rather artificial. A more accurate distinction is between **primary** and **secondary** carers. The primary carers have intensive interactions with and/or responsibilities for an individual or small case load. The secondary carers have a more specific input into the lives of a wider case load.
2. The RESORT system should focus on **assisting primary carers** in the **process of providing** RT, including access to information and the management of cases and case conferences. A key element of the RESORT provision should be the improvement in **on-going after-care** for a user of RT.

These primary conclusions should be set within a general finding of the questionnaire exercise. It is evident from the responses received that many people within the rehabilitation and care sector have not considered the potential benefit of remote rehabilitation technology. The focus of this field is care and rehabilitation, not on technology. Some technology is applied within the field, but generally within administration and to a lesser extent for the benefit of individual disabled people. Little has been done to address the requirements of carers or to apply technology in order to reduce the costs without sacrificing the quality of care.

Development of Functional Specifications

Based on the identified user needs the requirements and procedures for the RESORT telematic protocol have been laid out. The state of art in remote computer servicing has been studied and the functional specifications have been written down (D5.1).

Important decisions were taken by the consortium, e.g. the choice of IP (Internet Protocol) as underlying suite of protocols. In comparison to other solutions this ensured the possibility to use point to point ISDN connections (with a guaranteed bandwidth) and also the Internet (with its world wide connectivity) for establishing RESORT calls. The ISDN channel was specified to be the minimum bandwidth required for the link between Service Centre and client – to be able to show the full functionality – which might not be possible over analogue modems.

The Microsoft Windows95/98 operation system was specified to be the target platform for the prototype system, following the results of the Market Survey Report (D4.1). Nevertheless, a major outcome of the market survey (WP4) was, that it would be beneficial, if the RESORT system would, at least with few adaptations, provide cross-platform compatibility and not only serve Microsoft Windows9x users. The consortium, therefore, decided to develop at least the bottom layers of the RESORT system in (pure) JAVA – which is a novum but “should set a standard for future rehabilitation use of JAVA and will be an interesting activity to learn about” (commented by Richard Foulds, Research Professor and Peer Reviewer of RESORT Project).

The consortium agreed on a symmetric system architecture allowing to change a client to a Service Centre and vice versa. Additionally, it was decided to integrate existing software tools (audio, video streaming, data sharing, remote PC control) into the RESORT prototype, wherever those tools are serving the analysed and documented needs. This allowed the consortium to concentrate on RESORT specific items. The following alternatives of existing tools were analysed: *CU-SeeMe* (Cor-

nell University, WhitePine company), *iVisit*, *Netmeeting*, *Iphone*, *HoneyQ*, *Clearphone*. Preferences were given to the *iVisit* product, especially due to its video conference functionality and its API (Application Programming Interface). For remote PC control the *pcANYWHERE* product (Symantec) was tested and some rapid prototyping was done using the OLE programming interface leading to the result that RCI (Remote Control Interface) technology is urgently needed for real time synchronisation of RT systems, especially for single switch users, as standard application sharing technology does not provide real time transmission. The RCI definition was therefore one main task to be carried out.

Demonstrator Building and Verification

Two already existing and well proven RT software packages - for which the project partners forttec and ARCS own the copyrights - (a) *AUTONOMY* for environmental control, alternative and augmentative communication (AAC) and (b) *STEP BY STEP* for therapy/training had been upgraded by the "Remote Control Interface" (RCI). In parallel software for the RESORT-Controller and the Database / Database-Manager for the Service Centre had been implemented. Several prototypes were built, tested and improved in order to come up with a field test ready prototype system. In May 1999 the consortium was able to successfully demonstrate the first initial prototypes during a workshop in Vienna and to demonstrate and discuss the RESORT system structure during a workshop in Scotland in order to collect user feedback and comments.

Some delays were caused because the Contractor C3-ALH and the Associated Contractor A3-SRL/Dynamed had to terminate their participation in the project due to internal financial problems. A new contractor C5-IRV was introduced to the project in order to continue the work of defaulting contractor C3-ALH.

Some problems occurred as it was not possible to gain access to source code and API of the originally planned *iVisit* product, despite initial positive response from the holder of the license. This problem was worked around by using the Microsoft *NetMeeting* v3.0 product for human communication channels. Implementation of Resort controller by C4-DUMC needed more human resources than originally was expected. In order to avoid longer delays the implementation of the *Netmeeting* interface DLL and of the RESORT-DLL for RCI was shifted from C4-DUMC to C1-forttec in order to optimise the overall progress.

Some performance problems occurred. Due to the used JAVA technology the prototype system has a high demand of CPU power and RAM which leads to a low overall performance. The data rate of the functional prototype (D6.3) was low, so that one of the RT systems (Step by Step) was forced to use a separate data link for exchanging bigger data streams. Both issues later could be solved during redesign activities (WP8).

Component tests and the final system tests were done and documented in order to ensure that the different modules of the Resort system fit together well. In mid of November 1999 the functional prototype system (D6.3) was delivered to the validation sites.

The verification task was carried out between Oct. 1999 and June 2000 in 3 iterative cycles ensuring the involvement of users during the redesign activities. The outcome was an Advanced RESORT System prototype (D8.3) ready to enter the demonstration stage in September 2000.

Demonstration Phase

The Advanced Prototype System was installed and used under real life conditions by the target audience, and evaluated according to a predetermined method on the validation sites in Austria, Germany, Netherlands and United Kingdom. Workshops and Real Life Tests have been carried out in order to demonstrate the RESORT approach with a significant number of care persons and disabled users.

Deployment Phase

Currently, the consortium has started the deployment phase by presenting the RESORT project on conferences and in a special workshop for interested RT equipment manufacturers. License agreements for third party RT software are being prepared as part of the project's exploitation plan. The Remote Control Interface (RCI) and the underlying communication protocols are being prepared to be offered to the relevant standardisation bodies for further consideration and are being promoted by the consortium and the currently established Resort Interest Group (RIG).

Evaluation and Validation

For the verification and demonstration phase four validation sites (Austria, Germany, Netherlands and United Kingdom) were equipped with "service provider workstations" and several units for test-users. Main objective was to verify the concept and to redesign the system in an iterative way following user centred methodologies.

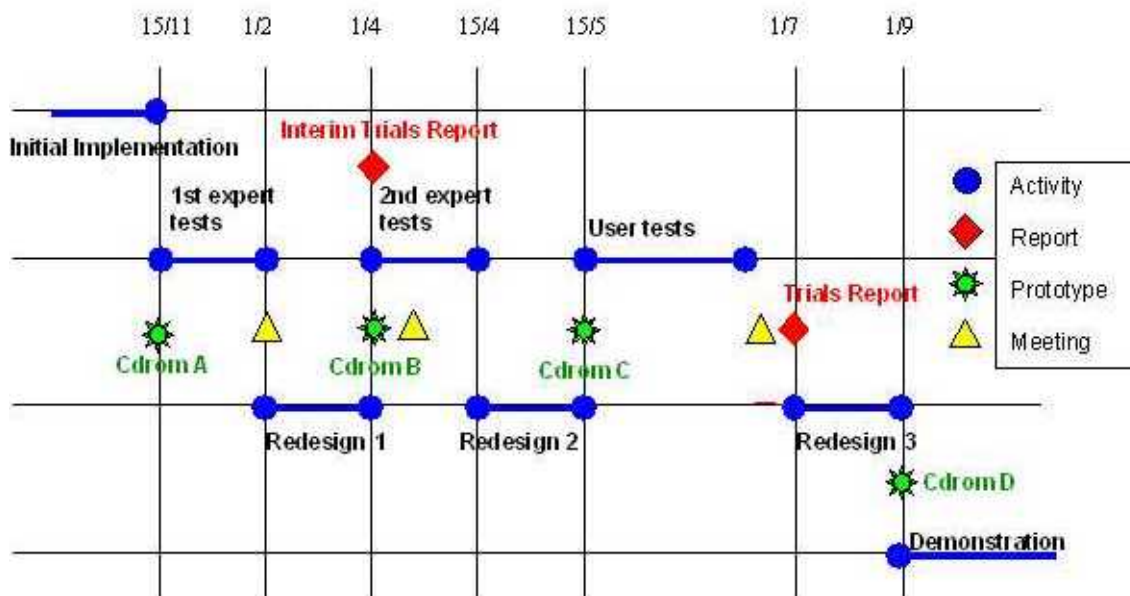

Fig.2: Time schedule of the iterative verification (WP7) and redesign (WP8) activities between fall 1999 and summer 2000. Three cycles have been passed, results of each user assessment have been discussed in dedicated consortium meetings in order to agree on redesign priorities for next release of prototype system. As result the Advanced Prototype System (Release D-4) could be delivered in fall 2000 for workshops and real life tests of WP9 (Demonstration).

Involvement of Users

During User Needs Analyses 37 interviews were conducted with disabled users, care persons, professionals, service providers, manufacturers, financing organisation. This formed the base for developing the user model and derive out of this the requirements for the RESORT system. During WP5 specification additional user involvement was done in order to develop use cases (scenarios)

for the daily life usage of future RESORT system. Additionally the built User Interface demonstrators were discussed with some expert users.

During development (WP6) two workshops had been carried out in Vienna and Perth in Scotland in May 1999. First laboratory prototypes were used and a demonstration of them given to the audience. User feedback was collected in open discussion and via questionnaires in order to ensure that priorities in implementation meets the needs of users.

Evaluation Criteria

While the functional prototype was delivered to the validation sites the evaluation schemas have been worked out. Three cycles of user assessment were done, a first expert test in November / December 1999, the results were discussed in a consortium meeting at A1-ELI in Axams, the improved release B of the prototype was again tested by expert users at the validation sites, next steps discussed during a consortium meeting at C4-DUMC in Dundee. Main phase of the verification were the user trials in June 2000. Test procedures were provided, guidelines and questionnaires worked out and translated into all 3 languages used in the consortium (English, Dutch, German). The questionnaires were also available online on the internal web page for verification.

During user trials 16 disabled users, 11 care persons and 4 researchers/expert users were involved on validation sites (total of 31). The internal documentation was used for presenting the results on the consortium meeting end of June in Vienna.

During Demonstration (WP9, September - December 2000) 15 workshops were conducted by 6 clusters of C-partners, associated partners and subcontractors in UK, NL, DE and AT. About 45 disabled users and 160 care persons, manufacturers, service providers etc. were involved (Total of 205). Calculating the amount of person hours which the prototype system was demonstrated we come up with 834 person hours, which are about approx. 6 Person Months.

A total of 14 persons (8 of them disabled) were involved in real life test of the advanced prototype system. C4-DUMC and the subcontractors USCS and TORT carried out long term real life tests (3 disabled subjects from USCS, one disabled subject from TORT). RECO and ARCS carried out short time tests with disabled subjects and fortéc conducted 2 sets of tests in Vienna under real life conditions were the RESORTable RT system has been installed at the users' home and was used in several sessions during a period of 2 weeks, mid of December.

Guidelines for running the real life tests and also for reporting had been worked out before.

Reviewing

The consortium strongly considered the comments from the Annual Review Process 1999. It was decided to emphasise the **modularity** of the prototype system in order to be as independent as possible from 3rd party products. The consortium is able to interface to other video/audio modules as soon as they are available. Also, concerning **exploitation** it was decided to start earlier than originally planned in the Technical Annex of the project in order to develop a detailed exploitation plan. Already existing connections with the CUSTODIAN project had been improved also concerning exploitation. During redesign activities awareness was given to **technology evolution** and emerging standards in order to come up with a prototype system ready and compatible for future needs. Some delays occurred in internal peer reviewing, which was done as contribution to quality assurance. Most of the deliverables had been **peer reviewed** by a market expert in Belgium and a research

professor in the United States. Comments and remarks of them were integrated into final versions of the peer-reviewed deliverables.

Collaboration

The consortium participated in the 4th Telematics for the Disabled & Elderly Concertation Meeting on May 5th, 1999, and in the IST Project Concertation Meeting, Applications relating to Persons with Special Needs, on March 1st, 2001, both took place in Brussels. Eleven Consortium Meetings were held, additionally several smaller face-to-face meetings. Internet Chat was used each 2 weeks among the C-partners coming up with 50 logged regular chats and additional 28 spontaneous chats. An internal BSCW server was maintained for exchange of documents, also internal email distribution lists.

Dissemination

Presentations about the RESORT project and papers related to RESORT have given on the following conferences or were printed in the following journals: 3rd Tide congress, Helsinki, 1998; Journal of Technology and Disability, 1999; AAATE conference 1999, Duesseldorf, Germany; EMBEC conference 1999, Vienna; ICCHP 2000 conference, Karlsruhe, Germany; 28th Martinstift-Symposium 2000, Gallneukirchen, Austria. Additional papers have been submitted for MEDICON 2001 conference in Pula, Croatia, and for the AAATE 2001 conference in Ljubljana, Slovenia.

The project web page is being maintained on URL <http://www.fortec.tuwien.ac.at/resort>. A project flyer in German, English and Dutch language is available. RESORT concept and prototypes were presented at the fairs Integra98 and Integra2000 in Altenhof am Hausruck, Upper Austria and on the ScienceWeek exhibition in Vienna, 2000. Press releases were done at the beginning of the project in 1998 and are planned to be done in March and April 2001 in synergy with the establishment of the RIG (Resort Interest Group). Interviews for mass media were given in 1999 for Austrian Freak Radio and in 2001 for the Austrian newspaper "Wiener Zeitung".

3. Results and Achievements

This chapter describes achievements and results of the RESORT project.

Concept and Specification of RESORT

Based on the User Needs Analyses and the Market Survey the original concept of RESORT could be refined and a detailed specification of the system was done (WP5). The overall system structure contains a Resort Service Centre (RSC) which can connect to RT users at home or in institutions via different types of networks: ISDN, xDSL, cable, LAN, wireless LAN, etc.

Software Prototypes achieved

The consortium released 4 revisions of the RESORT Prototype System which had been developed and improved in iterative cycles:

- Prototype System Revision A (D6.3 "Functional Prototype", November 1999)
- Prototype System Revision B (Spring 2000)
- Prototype System Revision C-2 (May 2000)
- Prototype System Revision D-4 (D8.3 "Advanced Prototype", Fall 2000)

All versions were delivered on CD-ROMs providing an installation package for the RESORT prototype system, the RT systems AUTONOMY and STEP BY STEP and the third party modules. The revisions have passed system integration tests which were carried out and documented by forttec.

Implementation and Redesign Based on User Involvement

During Implementation (WP6) two workshops were carried out in Austria and in Scotland (spring 1999) in order to present interim laboratory prototypes and demonstrators to potential future users. During Redesign (WP8) three cycles of user involvement were done: Expert User Tests of the Revision A Prototype (winter 1999), second Expert Tests of the Revision B Prototype (spring 2000) and User Trials of the Revision C Prototype (June 2000). During Demonstration (WP9) the Prototype Revision D was tested extensively during several workshops and real life tests in fall and winter 2000.

As a result of the user assessment the following improvements were implemented:

- The overall system performance was improved
- The user interface was improved to enhance the user friendliness
- An international version of the database manager was realised
- The installation procedure was improved
- Additional implementation of an automatic file transfer (which allows the RT system to request a file transfer of needed multimedia files autonomously from the Resort Controller without the need of user interaction)
- Possibility to invoke a RESORT call from inside an RT system
- Integration of application sharing functionality
- Dutch Language version of the RT systems

- Dial-Up module for establishing automatically a network link from Client to Service Centre should be added to RESORT controller software
- A set of bug fixes and minor modifications (smaller video window, auto-saving of window positions, sharing security ...) should be added

In order to support validation sites two internal Web Pages for Verification and Demonstration had been established:

- <http://www.fortec.tuwien.ac.at/resortverification>
- <http://www.fortec.tuwien.ac.at/resortdemonstration>

Information about current versions, available installers and upgrade kits, bug reports, trouble shooting tips and much more have been provided there.

Main Functions of RESORT Prototype System

This section describes the functionality and features provided by RESORT system from a technical point of view.

RCI - "Remote Control Interface":

- allows remote monitoring, support and interaction
- supports interactions between carers assisting disabled users in the use of RT (remote launching of RT systems, Version information, etc.) without the need of detailed knowledge or practice.
- security: only applications with RCI can be accessed by the RSC
- facilitate "real time synchronisation" of RT systems: RCI provides data and message channels which allows faster synchronisation even over narrow bandwidth for single switch user.

User-Interface:

- simple, scalable and only one per platform: easy to use, adaptable to the needs of the individual user.

Real-Time Communication & Interaction:

- to bring remote care persons to client
- to facilitate virtual visits: chat*), hands free audio, video

File Transfer:

- user initiated: Operator can manually transfer files
- automated initiated: RT system can request an automatic file transfer using the RCI specification

Database-Access:

- Security: e.g. for checking the user's and the operator's password
- scalable UI: the parameters related to a user are stored
- info about user: provided to operator (if storing is agreed by user)
- info about RT system: version info, used input devices, etc.
- network setup: e.g.: which Dial-up Link to use
- ensures flexibility: DB server can run on another platform

Invoke of other Technologies, e.g.:

- network monitor *): information about network performance and load
- application sharing: control over a dedicated application on remote PC
- desktop sharing **): full control about remote PC
- dial up network links: automatically establish network connectivity
- all of them are integrated into the one UI of RESORT: in order to make it easy to handle and to understand

Platform independent:

- Kernel of RESORT runs in Java Virtual Machine (JVM). Therefore it is able to run on portable devices (Windows CE), proprietaire solutions (e.g. environmental control systems), or PDAs

Security:

- password level: user and operator have to enter password
- encryption *): encrypted transfer of (sensitive) data
- network level: e.g.: point to point network links are more secure than connectivity via Internet

Additional other RT systems

- other than Autonomy and Step by Step: These RT systems serve (only) as catalyst for demonstrating the potential of RESORT concept.

RESORT system was designed as a modular system. So future adaptations and additional features can be added easily. During redesign activities the consortium focused on those features which were identified as to have the highest priority from point of view of the RESORT validation sites.

*) Due to priorities and lack of resources the chat, the encryption functionality and the network monitor have not yet been implemented. Note, that chat functionality could be demonstrated and tested in real life test by sharing text editors.

***) Not yet implemented due to known technical problem in Netmeeting API.

The Advanced RESORT Prototype System offers three different modes of operation:

- In the telephone mode RESORT provides hands free communication between user and service provider. If the bandwidth is large enough an additional video link can be established.
- In the student-teacher mode an additional data-link is established. The service provider will load exactly the same RT application as the user is running. The two applications - at the user's site and at the provider's site - will be synchronised via the data link.
- In tele-service-mode the service provider will have the possibility to down- and upload files from and to the user's PC, modify configurations and test the changes he/she has made.

Technologies and Components

The core of RESORT has been implemented in Sun Java 1.3. The system exploits existing technologies for tasks like video / audio transmission according to H.323 specification and desktop/application sharing according to T.120. These applications are invoked, but not re-developed. Specific new features such as the RCI technology which allows real-time synchronisation between local and remote RT systems (even when using automatic scanning) have been developed.

RCI stands for Remote Control Interface which implements a link between the RT system and the so called RESORT controller (RC). The RCI and the RESORT protocol allow synchronisation in real time. This is possible as only small data messages are transferred instead of changed screen contents. This method dramatically reduces the required bandwidth and enables the RESORT sys-

tem to provide real time monitoring of single switch users. The Resort controller module (RC) is linked to (a) communication modules for video, audio and chat, (b) to the database, (c) to the RT system and (d) via network interface to the remote RC.

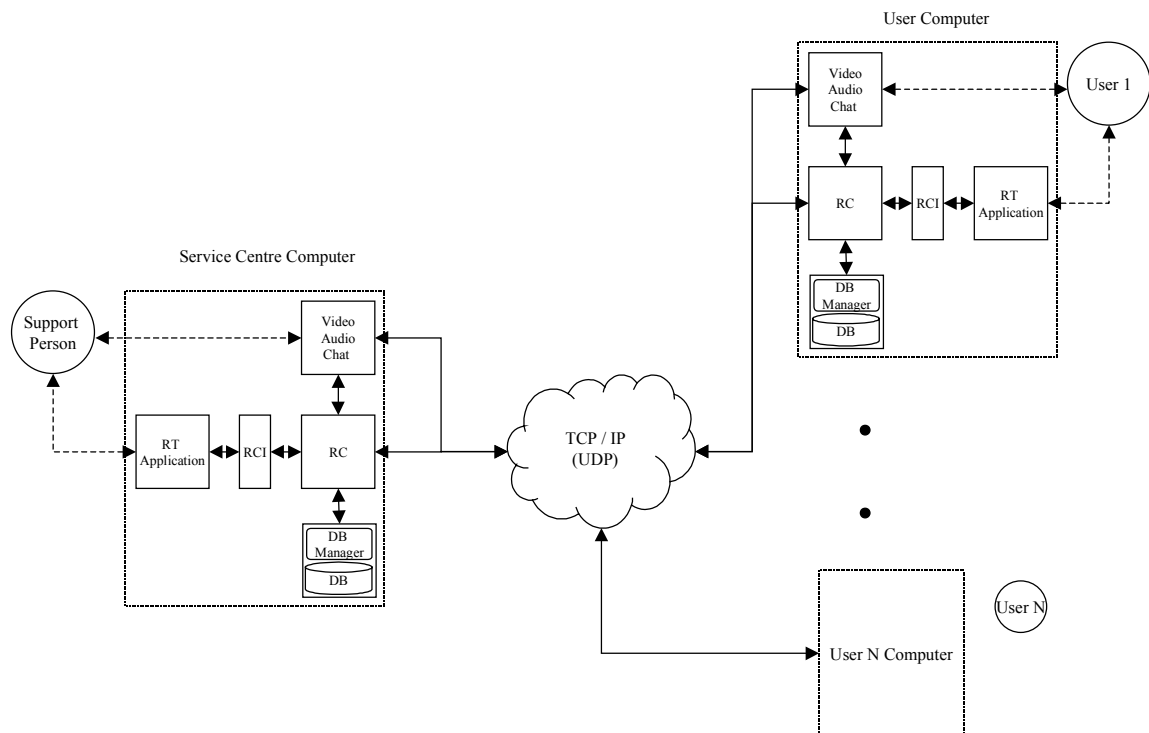

Fig.3: Overview of RESORT system structure: On the left hand side the RESORT Service Centre (RSC), on the right hand the RESORT Client PCs (at special schools, at residential areas, private home, ...). In between the Network (LAN, ISDN, cable, xDSL, ...). One RSC can handle several clients, but only one by one.

Software, Hardware and Network Requirements

For a RESORT Client the PC platform should at least meet the following specification:

- Multimedia PC / Portable with CPU: 233 MHz Pentium
- RAM: 64 MB
- Screen Resolution: 1024 * 768
- Operating System: Microsoft Windows 9x
- Network Link: one channel ISDN (64 kbps) or better

Meeting this specification is necessary for an acceptable system performance, especially concerning quality of audio and video.

For a RESORT Service Centre it is recommended to use

- Multimedia PC with CPU: 300 MHz Pentium or better
- RAM: 128 MB
- Screen Resolution higher than 1024 * 768 (generally it should be better than at Client)
- Operating System: Microsoft Windows 98 SE
- Network Link: one channel ISDN (64 kbps) or better

for Client and Service Centre it is recommended to use:

- Multi Channel Audio Card (e.g. SoundBlaster Live)
- WebCam with integrated Microphone (recommended: USB)

Scaleable User-Interface

The user interface of the Resort controller can be tailored according to the needs of the users. Although the full functionality is always available, the degree of complexity of functions and information shown to the individual user can be varied within a wide range.

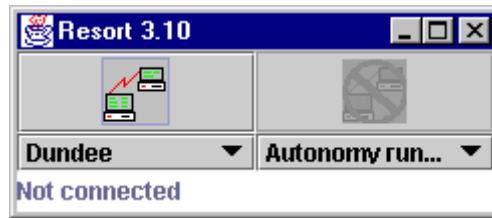

Fig.4: Example of User Interface of RESORT Controller. Clicking on CONNECT Button (left side) connects to the RESORT Service Centre. This User Interface is suitable for care persons using standard mouse or keyboards or for disabled users working with keyboard mouse or mouse emulation.

The user interface of the AUTONOMY runtime program is very flexible, figure below is only an example to explain some basic elements of the user interface: The focus shows which icon will be activated once the user makes a selection (he/she may do this by using a lot of different input devices). The focus is either moved by the user or automatically by the computer (dependent on the abilities of the user). An icon is represented on the screen with a picture and an explaining text (fully configurable).

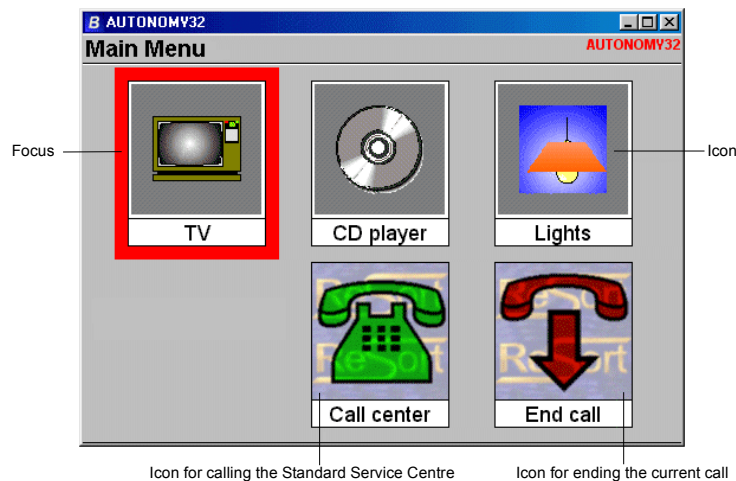

Fig.5: User interface example for starting a RESORT call to a Service Centre from inside the AUTONOMY runtime program. This can be used easily even by severely disabled user. Icons in upper line control (a) TV, (b) CD-Player, (c) lamps. Icon in 2nd line (a) establishes a RESORT call to Service Centre and (b) closes a RESORT call. Note: The RESORT controller needs to be running, but can do so as invisible task.

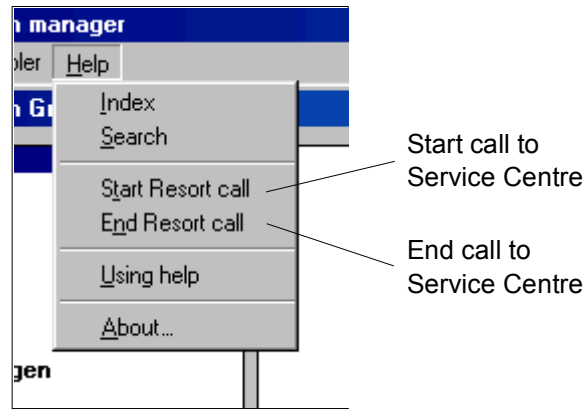

Fig.6: UI for care persons for starting and ending a RESORT call from inside the Setup- and Test Tool and the Configuration Tool of the RT system AUTONOMY. Both applications are intended to be used by care persons.

It is possible to assign some form of audio, too (including speech synthesis). Internally, an icon contains a list of commands which are executed once the icon is activated. The icon “Call Centre” is used to establish a call to the standard service centre. The user simply moves the focus to this icon or waits, until the computer moves the focus to it. Then he/she activates the icon by pressing the select button. Ending a call is done in a similar way.

The Configuration Tool and the Setup- and Test Tool do not use their own synchronisation protocol. The application sharing feature of the RCI is used instead. Nevertheless, it is possible to start and end a call to the standard service centre from within these programs by simply choosing a function from a menu.

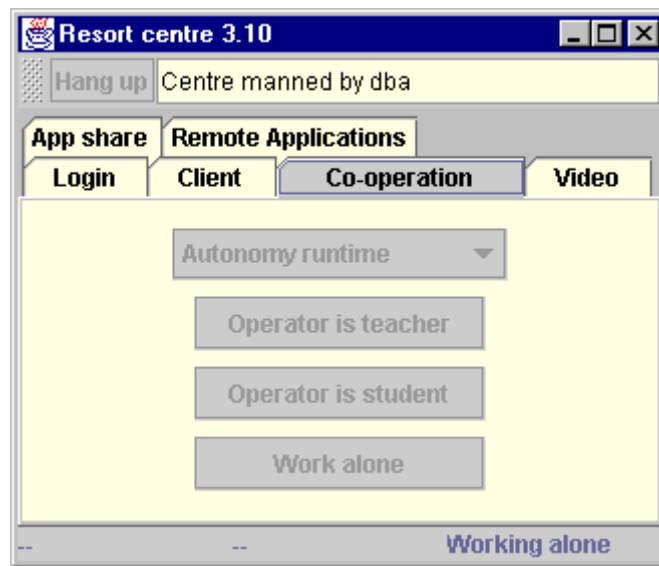

Fig.7: User Interface of RESORT Service Centre: Form for selecting co-operation mode.

Compliant with Existing Standards

The current version of the Resort system uses Microsoft NetMeeting to provide video and voice communication. NetMeeting is controlled through the Fortec DLL using the Java Native Interface (JNI). Control functions are defined by Java Interface classes. Therefore the design is modular and NetMeeting could be replaced with minimal changes to the system. The choice of NetMeeting was dictated by Microsoft's provision of a freely available and well documented API. In addition Net-

Meeting complies with H. 323 video-conferencing, H261 video, G.711 audio and T.120 data conferencing standards.

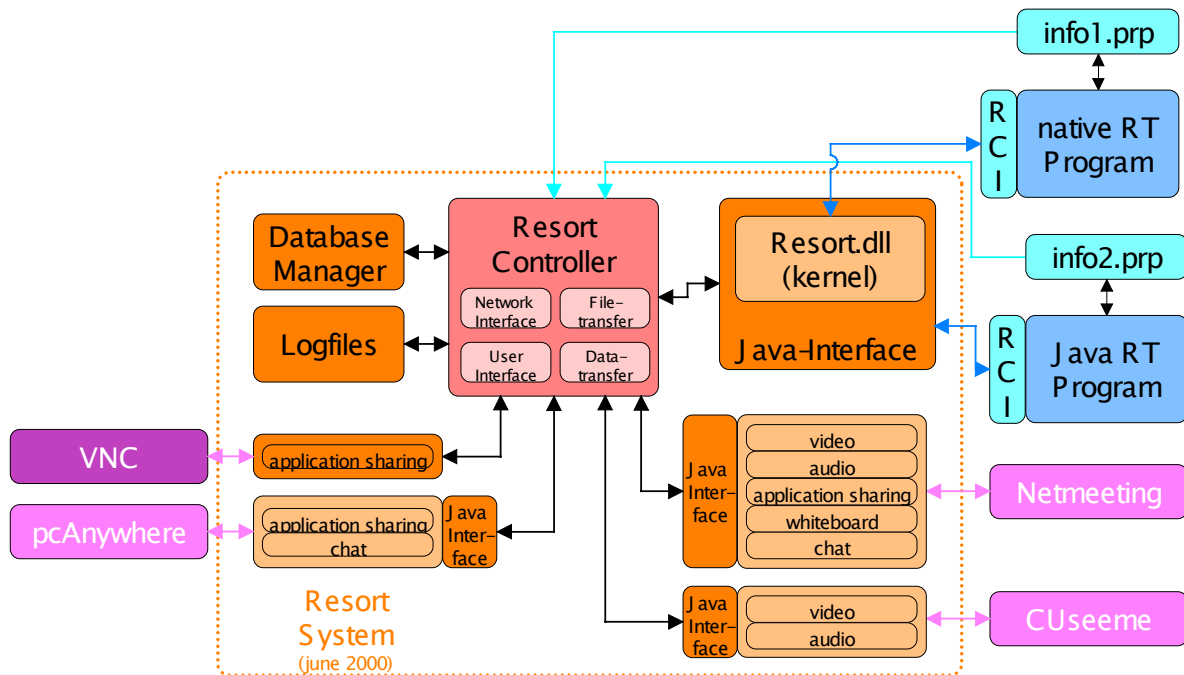

Fig.8: Modules and Interfaces of the RESORT prototype system. Different available third party products for audio, video and data conferencing can be used. The current prototype uses H.323 and T.120 implemented by Microsoft Netmeeting v3 product.

As network protocol IP is used. TCP/IP for control messages, UDP mainly for audio and video. In order to test and demonstrate the benefits of the system 2 existing RT systems have been equipped with a Resort interface.

In order to ensure a high level of flexibility several internal interfaces were introduced. The outcome is a highly modular system which allows to exchange specific parts without the need of adapting other parts. This increases the independence from 3rd party products for audio, video, application sharing, desktop sharing, etc.

Proposed RESORT Standard: Remote Control Interface v3.21

The RESORT consortium has defined a protocol for remote service provision. The current version of this RCI (Remote Control Interface) protocol is v3.21, December 2000. For demonstration purposes this protocol has been integrated into 2 already existing RT systems: the AUTONOMY system for environmental control and alternative and augmentative communication (AAC) for severely and multiple impaired persons and the STEP BY STEP system, a PC based learning and training system for disabled children.

The RCI Definition v3.21 of the RESORT Protocol provides functionality for a 3rd party RT system in order to allow this RT system to

- attach and de-attach to/from the local RESORT controller
- send and receive data to/from the local RESORT controller
- send and receive messages to/from the local RESORT controller
- request a file transfer from the RESORT system
- be started / end locally and remotely by the RESORT system

- send status information to the RESORT system
- enter student/teacher mode controlled by operator at Service Centre
- register to the RESORT system via the PRP-file architecture
- a multitude of additional features like PINGing (Are you alive?), ...

The defined and tested RESORT protocol is one of the major achievements of the project.

Integration of Remote Control Interface (RCI) into an RT System

The AUTONOMY runtime program uses drivers to communicate with its environment. So it was only natural to write a driver to integrate the RCI into the system. The basic structure of the AUTONOMY run-time program is shown in figure below.

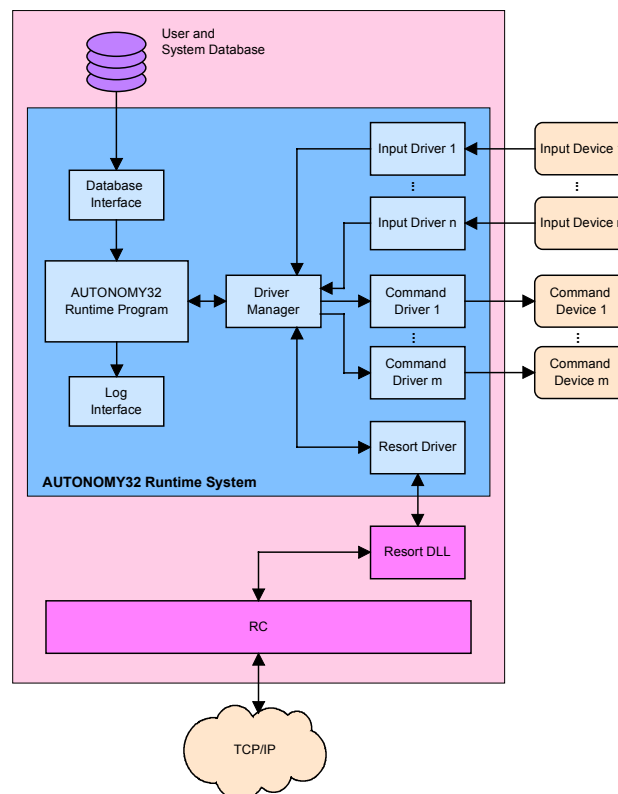

Fig.9: Basic structure of the AUTONOMY runtime program with Remote Control Interface (RCI) implemented by Resort Driver which is communicating via the Resort DLL with the local Resort Controller (RC).

The Resort driver calls the functions of the RESORT.DLL to initiate different actions and contains the data and command callback functions defined in the RCI. The driver also monitors the runtime program to trace the actions done by the user and the system. When running as a master, the driver uses this information to compose the necessary synchronisation messages for the slave. When running as a slave, the driver uses this information to wait for the system to complete the actions initiated by the synchronisation messages.

Usage of Transparent Data and Messaging Channel

The RESORT driver of the AUTONOMY runtime program uses the RCI_Put_Data function to send internal messages and data to the driver on the other system. The driver on the other system uses the RCI_New_Data callback and the RCI_Get_Data function to receive these messages and

data-packages. This mechanism directly connects the AUTONOMY systems on the two computers involved.

Additionally, each driver uses the RCI_Put_Cmd function to send commands to the RESORT controller and the RCI_New_Cmd callback to receive answers from the controller. The RESORT driver of the AUTONOMY runtime program uses a simple yet effective protocol. Currently, this protocol only needs two data structures (the structures are described in Pascal syntax).

Interface-DLL for 3rd party RT Systems

The consortium developed the RESORT Interface-DLL according to the RESORT Protocol. This RESORT Interface DLL is the link between a 3rd party RT system and the RESORT system. It has been tested with the 2 RT systems AUTONOMY and STEP BY STEP.

The RESORT-DLL is the local link between one or more RT-programs and one RESORT-Controller (running on Client or Service Centre). This DLL is the tunnel between the separated process-workspaces and ensures a secure, fast and operating system-friendly way of communication between these programs. Additional part is the Java Extension which allows the JAVA based RESORT controller to communicate with the native based sub modules and the RT systems.

Although the user of the RESORT system is not confronted directly with this RESORT-DLL it nevertheless is one of the most important outcomes of the RESORT project. 3rd party developers do not need to know the internal details of this DLL but need to have access to the interface specification.

Using Win32, each program runs in his own process space. Memory access or handles to devices and so on are only valid within this process space. If two or more programs want to communicate or to exchange data, some kind of interprocess-communication or interprocess-data-exchange must be used. These techniques have to be done by the RESORT-system and the 3rd party RT programmer should not have the need to invest much effort in this part.

A rather sophisticated technique has been used for implementing the RESORT DLL. Please refer to D8.2 for details. A very easy to handle interface was designed to be used by the RT programmer, the whole interprocess stuff is completely hidden. The RESORT.DLL uses some interface-mechanisms like callbacks and pointers, which are not suitable for Java. Therefore a second DLL called RESORTJ.DLL was programmed to build an interface between the needed native functions and the special needs of the Java language.

The gap between the native-world and the Java-world is wide, but Java uses a special interface called JNI (Java Native Interface), which makes it possible to bridge this gap. The consortium decided to use byte-arrays instead of pointers to memory and to use the Java-callback-methods instead of native-callbacks (which needs pointers to compiled code). The RESORTJ.DLL is only an interface between these two worlds and includes no further functions. So the tasks are separated quite clear: The interprocess-communication is done by the RESORT.DLL and for that programs, which use Java, the RESORTJ.DLL interfaces the provided functions of the RESORT.DLL. Some new error-messages and the affiliated info-texts were integrated in the RESORTJ.DLL in order to have the same functionality and information for error codes occurring in the interface-DLL as in the RESORT.DLL itself.

Preliminary RESORT SDK

The RESORT Software Development Kit (RESORT SDK) provides material needed by a 3rd party manufacturer of RT applications in order to make his / her own RT system RESORTable. The SDK needs to consist of a manual (explaining how to turn a not RESORTable application into a RESORTable one), the API, some sample software and source code.

Based on the results of WP8 (Redesign) and WP2 (Documentation) FORTEC compiled a first version of a SDK containing guidelines how to integrate the RESORT software interface to other applications of the RT field. Some sample application in Visual Basic is included. This SDK will be provided to interested manufacturers on a commercially secured base (confidentiality agreement to be signed). Currently (February 2001) this is being done for Hindelang-Software, Germany

Results and Achievements in Workshops and Real Life Tests

The advanced prototype system (Revision D-4) was demonstrated in 15 workshops organised for care persons, disabled users, manufacturers and service providers in Austria, Germany, The Netherlands and Scotland. Additionally real life tests have been carried out.

For the real life tests different network settings were used: (a) Dial up link via a 64 kbps ISDN channel from the client to backbone of the university network, (b) cable network from client to university network, (c) LAN, (d) wireless LAN in Scotland including ISDN bridging between validation site and university.

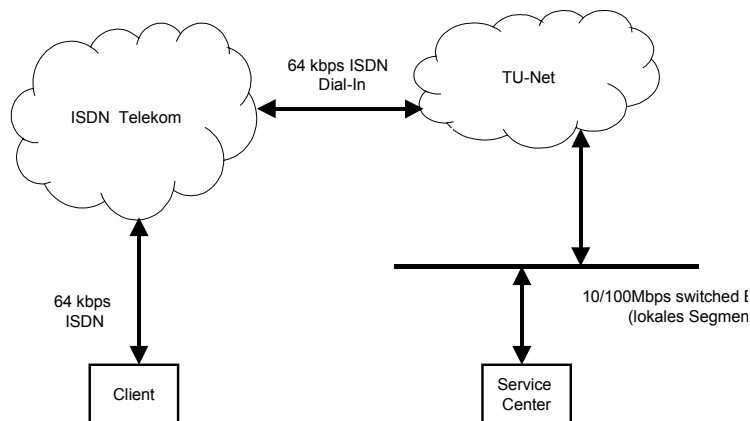

Fig.10: ISDN link (64 kbps) from Client platform to Service Center (RSC). In Vienna typically used by disabled Subject MH testing RESORT at her private home in daily life usage.

The first real life tests involved 2 disabled users on 2 different locations in city of Vienna. Focus was given to support single switch mode, to let disabled users call the Service Centre autonomously, to remotely configure the RT system and to train the user and the care persons remotely.

The results from the real life tests are very encouraging. Existing barriers in the service provision in the field of RT can be reduced significantly. The RESORT advanced prototype system demonstrated a lot of benefits which will help to overcome existing barriers in the field of RT service provision.

Resort Services

Using the RESORT prototype system provides a new type of service to the users and customers of the AUTONOMY system. Without having to be locally present the Service Center can provide tele-training, trouble shooting and maintenance, virtual visits, monitoring and much more to the care persons and the disabled end users of the AUTONOMY system. This will increase significantly the efficiency of usage and will reduce the costs of service provision. Additionally the delay between service request and delivery of service can be reduced. This service has been tested during the demonstration phase of the RESORT project in December 2000.

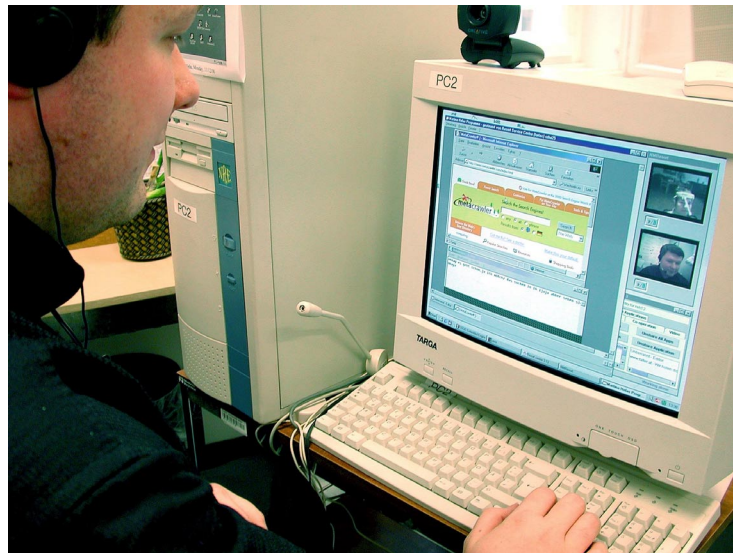

Fig.11: Operator in dialogue with head stick using Subject MH (top right corner of screen) in a RESORT call. Picture taken on RESORT Service Centre in laboratory of forttec, Vienna, on 15/12/00. Operator (GS) provides tele-training for using search machines in web browser (left side of screen shows browser running on client MH being shared by RESORT service centre).

The RESORT Service for the RT system AUTONOMY provides:

- remote introduction to the RT system AUTONOMY
- remote training in using AUTONOMY
- remote configuration and customization of RT system
- remotely upgrading the AUTONOMY system
- maintaining the AUTONOMY system (backup data, analysing log files, ...)
- transferring multimedia data
- exchanging user databases between several AUTONOMY RESORT clients
- providing therapeutic support remotely
- support for non-speaking and severely disabled users (head stick, single switch)
- easy way for exchanging experiences between novice and well experienced care persons
- mean to bring end users, primary and secondary care persons, service providers, developers together while saving time and money
- early prototyping support for development of future versions of the RT system AUTONOMY

Currently no service is known that provides all these features. Some service providers are using commercial off the shelf systems for remote support, but these services cover only part of the AUTONOMY RESORT service. This service needs a RESORTable version of AUTONOMY and an installed RESORT system.

RESORT Exploitation

The uniqueness of the RESORT project is the provision of a totally new tool and way of service provision in the RT sector. It is designed to meet the specific needs of this sector and one of the main benefits is the user friendliness and usability (although elderly people are less PC literate it is nevertheless easily accessible to them). Furthermore the implementation of Remote Control Interfaces (RCI) is able to support single switch users and ensures a very efficient and fast way of communication between two applications over a network). RESORT should be seen as a universal tool for handicapped persons and their local facilitators, independent from the type and the degree of the disability.

The following products and services are outputs of the RESORT project and are to be exploited:

Product Type	Products
RESORT Software Products	RESORT Basic Tool Software Package (Service Centre and Client Interaction Software)
	RESORTTable AUTONOMY
	RESORTTable Step by Step 3
	New RESORTTable Products (3 rd Party Products)
RESORT Services	General RESORT Helpdesk
	RESORT Service (Centre) for AUTONOMY
	RESORT Service (Centre) for Step by Step 3
	Further Service (Centres) to be developed
RESORT Development Support	RESORT DLL for 3 rd Party Developers
	RESORT Software Developers Kit (SDK)
	Open RESORT Standard
	RESORT Container Software

Table 1: RESORT Products and Services.

The products marked grey are already very far developed (at least demonstrated prototypes) and have very high exploitation potential. RESORT has been successfully demonstrated and evaluated in workshops and in real life test situations.

The following product/market combinations are important for RESORT exploitation and there are strategies outlined for each:

- RT companies
- AUTONOMY Product/Market Combination
- Step by Step 3 Product/Market Combination
- (Special) Education
- (Physio) Therapy
- Information Centres and Resellers
- Non RT market

In the first stages of exploitation after project end there will be a focus on product finalisation (some redesign activities incl. the implementation of additional features). Investors and potential exploiters are welcome and searched for. Furthermore the support of interested 3rd party developers (potential co-operations and contacts already established in the framework of the project) will be stressed. Demonstration of the RESORT outcome is still very crucial to convince financing authorities and

prospective users (to promote exploitation). Therefore, the possibilities of a demonstration project and follow-up projects are important to be considered.

RESORT has not only developed software tools or software add-ons but furthermore evaluated the remote service provision in the RT sector and worked out concepts. The RESORT system will highly enhance the service delivery of technical and therapeutic support in the rehabilitation sector. Some current observations might even allow the consortium to state that RESORT prototype system will trigger some kind of rethinking and redefinition of currently existing service delivery. No combined tools for remote support of Rehabilitation Technology are currently available in the RT sector and standalone solutions are rarely used. It is likely that the advent of RESORT will also motivate persons who up to now have refrained using RT due to a lack of available service and support.

4. Conclusions and future plans

The project verified the feasibility of a Remote Support System specifically designed for usage in the RT market. Additionally the user feedback gathered by the consortium while carrying out workshops and real life test has shown the significant demand for such a product and service. From the technical point of view an improvement of stability of the RESORT prototype system is urgently needed in order to achieve a stability level which is necessary for a commercial product.

Post Project Co-operation – The Resort Interest Group (RIG)

As framework for further co-operation after completion of the EU funded DE-4208 RESORT project in December 2000 currently the Resort Interest Group (RIG) is being setup. Main objective of the RIG is to administer exploitation rights, to co-ordinate the exploitation efforts and make arrangements concerning revenues from exploiting the results of the RESORT project. During a partner's membership in the RIG this partner agrees that all his foreground rights in the RESORT Project shall be executed as if these rights had been transferred to the RIG. Membership in the RIG has been offered to all A-Partners, Subcontractors and Test Sites of the RESORT project. The partners agreed to set up an editorial committee for creating detailed by-laws for the RIG until June 1, 2001. Currently (February 2001) all C-partners, A-partners and subcontractors have already signed or have at least expressed their intentions to sign. Notwithstanding the future by-laws of the RIG, the objective of the RIG shall be:

- Developing a coordinated strategy for public relations, dissemination and exploitation of RESORT.
- Establishing and maintaining a RESORT user club.
- Bundling and co-ordinating future development efforts of RESORT as well as initiating future follow-up projects.
- Fostering mutual information flow between the partners.
- Creating and observing rules for the distribution of royalties coming from future revenues by observing past and future contributions of a partner to the development, dissemination and marketing of RESORT.
- Development and maintaining protocols and standards with respect to the RESORT technology. Producing and providing software development support for potential manufacturers of "Resortable" products.
- Establishment and protection of a name or trade mark for „Resortable" Products and „Resortability".
- Development and administration of a quality label for "Resortable" Products.

Presentations to and Support of Interested Parties

Additionally to the RESORT prototype software the RESORT protocol has been developed which allows other manufacturers of Assistive Technology systems to adopt the RESORT protocol for their products in order to strengthen their position in the RT market. Presentations and demonstrations of RESORT concept have been given to interested companies in the field of RT (Meschik und Partner KEG, Otto Bock Industries) and outside. An interim RESORT SDK has been compiled by C1-fortec mid of February 2001 due to demand from market. It has been sent to one of the interested parties (a German SME) in order to let them integrate and test a basic RESORT-ability into an already available 3rd party RT application called MULTITEXT. A non-disclosure agreement had been signed before hand. This evaluation is being supported by A2-RECO, a company which already is selling this 3rd party product.

The Federal Educational Institute for the Blind (BBI) in Austria is currently planning an information centre where the RESORT technology might fit into and might be a good technical basis. The National Education Institute of Blind People has a very good (high speed) computer network infrastructure and internet access. Representatives of the National Education Institute of Blind People said that they are very interested in long-term demonstrations (especially in testing RESORT with special hard- and software used by blind people).

It is planned to contact organisations and companies which already have suitable structures for introducing RESORT (e.g. call centres), in order to establish the SERVICE in addition to the to be improved PROTOTYPE SYSTEM.

Conclusion

RESORT has always tried to provide at least the bottom layers of the system platform independent. This makes the RESORT system future proof and ready for overseas markets. Since the basis of RESORT is developed in Java the basic tool is to a high extent platform independent. It may also be considered for other operating systems and systems to come.

Demonstration of RESORT Advanced Prototype system brought good overall results and very high interest by the participants. The participants were very impressed by the features, possibilities and benefits RESORT will introduce in the rehabilitation sector. RESORT was said to have a very high potential even without features not implemented now. People involved in the field of computers and RT in the rehabilitation field said that RESORT could be used as it is now as soon as it is stable enough.

5. Contact details

Project Name: RESORT - Remote Service of Rehabilitation Technology
Project Number: TAP DE-4208
Timescale: 01.05.98 - 31.12.2000
Duration: 32 Months
Overall cost: 1,260.267 EUR
CEC contribution: 870.000 EUR

Main Contractors:

fortec - Research Group on Rehabilitation Technology, IEMW, Vienna Univ. of Technology (AT)
Austrian Research Centre Seibersdorf (AT)
Micro Centre – Univ. of Dundee (UK)
iRv – Institute for Rehabilitation Research (NL).

Validation Sites:

Elisabethinum Axams (AT)
RehaKomm – Langenau (DE)
Upper Springland Capability Scotland (UK)
Tayside Orthopaedic and Rehabilitation Technology Centre (UK)
Stichting Revalidatie Limburg - Fransiscusoord Valkenburg a/d Geul (NL).

Project Coordinator:

Wolfgang L. Zagler
fortec – Research Group on Rehabilitation Technology
Institute for Industrial Electronics and Material Science
Vienna University of Technology
Favoritenstrasse 11/366-1B
A-1040 Vienna, Austria
Tel:+43 1 58801 76611
Fax:+43 1 58801 36697
E-mail: resort-fortec@fortec.tuwien.ac.at
Project URL: <http://www.fortec.tuwien.ac.at/resort>

Resort Interest Group (RIG):

c/o fortec, see above
Contact: Paul Panek, Wolfgang Zagler
E-mail: resort-fortec@fortec.tuwien.ac.at
URL: <http://www.fortec.tuwien.ac.at/resort>