

# A SimEvents/Simulink -based Solution to ARGESIM Benchmark C8 'Canal and Lock System'

Dominik Brunmeir<sup>1\*</sup>, Matthias Rößler<sup>1,2</sup>

<sup>1</sup>Department of Analysis and Scientific Computing, Vienna University of Technology, Wiedner Hauptstraße 8–10, 1040 Vienna, Austria; \*[dominik.brunmeir@gmail.com](mailto:dominik.brunmeir@gmail.com)

<sup>2</sup>dwh GmbH, Neustiftgasse 57–59, A-1070 Vienna, Austria

SNE Simulation Notes Europe SNE 25(1), 2015, 55-58  
 DOI: 10.11128/sne.25.bn08.102285  
 Received: July 10, 2014; Revised February 10, 2015;  
 Accepted: February 15, 2015;

**Abstract.** This paper discusses a model for a system of two canals and a lock, with transiting ships and their average transit time. Different policies for the lock are investigated and variance reduction experiments are conducted.

## Introduction

The Model, as described in ARGESIM Comparison C 8, was implemented in Simulink, and is an example of modelling complex logic. The statistical analysis was done in Gnumeric, an open-source Spreadsheet application. The use of Simulink made it easy to monitor the various outputs.

## 1 Description of the System

The system consists of two canals and a central lock. The ships pass through in batches in a single direction. So it is necessary to implement a logical system that switches the direction of transversal. We have to apply rules to make sure that after a certain amount of ships, the other direction gets access to the lock as well, even if there are still ships waiting. This maximum amount is called Eastmax or Westmax, depending on the direction.



**Figure 1:** Simple schematics of the Canal and Lock System.

### 1.1 Canal

A ship always has to pass through two canals to get through the system. If it is an eastbound ship it will first move 14 minutes through the west canal, pass the lock in a variable amount of time and then pass through the east canal in 18 minutes. A westbound ship will do the same in reverse. Because the canals are too narrow to fit two ships side by side, the whole system can only be traversed in one direction simultaneously.

### 1.2 Lock

The Lock raises or lowers the waterlevel to the other canal, when a ship is passing through the system. It can hold only one ship simultaneously and needs twelve minutes to raise or lower the water. A ship takes five minutes to enter and five minutes to leave the lock. The time a ship spends in the lock may vary, because the lock is able to raise or lower the waterlevel to the approaching ship as soon as a ship enters the canal preceding the lock. The minimal time spent is therefore 22 minutes, and the maximum time 34 minutes.

### 1.3 Direction

As mentioned, the canals are too narrow to let ships move through simultaneously in both directions, so rules are necessary to allow ships to transit with no deadlock as two ships with opposite directions approach one canal. If there are no ships in the system, when a new ship arrives, it enters the system immediately and starts a cycle. If another ship arrives, while the previous ship is in transit, and if it travels in the same direction, it will also enter the system and is added to the cycle unless Eastmax or Westmax ships have entered the system in a single cycle. If Eastmax or Westmax is reached, the following ship is denied access and the direction will be reversed after the last barge of a cycle has passed

through the system. In case there is no ship waiting for entrance in the opposite direction, a new cycle in the same direction will begin.

## 2 Description of the Model

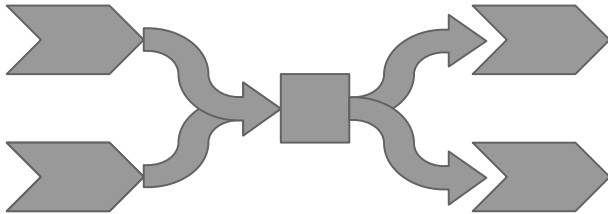

Figure 2: Simple schematics of the Model.

The model is implemented in Matlab Simulink with the help of Matlab SimEvent blocks. The ships are represented by entities which move through several gates and servers. For the implementation we changed the basic structure to create a more linear flow of all entities. Instead of two bidirectional canals, we built the model with two unidirectional canals, with variable lengths of transit time dependant on the origin of the ship entities. Therefore *east* and *west* is a bit of a misnomer, but is still applied to the variable and function names to allow an easy way to match the corresponding building blocks of the model to the system.

**Overview.** At first glance we see in 3 the flow of the model going from left to right, with the cycler subsystem on the top controlling the flow of the system. We will now detail the various important subsystems further.

**The Waiting Line.** The ship entities are generated by a time based entity generator, which gets its intervals between ship generation, from the start script. Those entities continue to server blocks, that represents the waiting line before the canals. Given that the procedure of passing through the first canal is equal for eastbound or westbound ships and only differs in the amount of time spent when passing through the canals, we used an input switch block to open the first canal block for the appropriate entity. This switch block is controlled by the cycler subsystem.

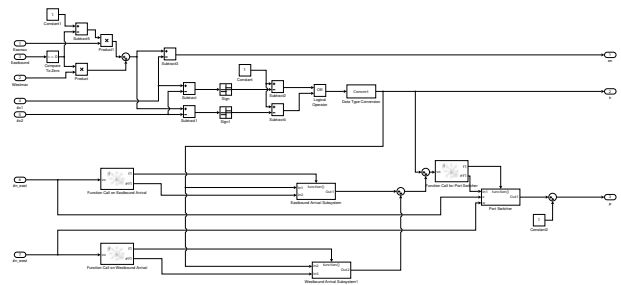

Figure 4: Cycler Subsystem

**The Cycler Subsystem.** A subsystem called cycler implements the logic behind the switching of the direction and opening the first canal. It also secures that only Eastmax or Westmax number of ships may pass through in one batch. Instead of reversing the direction it flips a switch block to allow the right amount of barges, moving in the right direction to pass through the system. The upper part, as seen in 4, decides if Eastmax or Westmax is reached, while the bottom part uses function calls on arrival of new entities in the waiting server blocks to decide whether the ship entity may continue into the system.

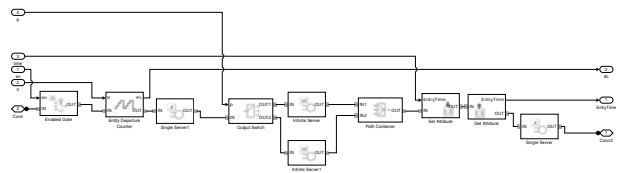

Figure 5: First Canal Subsystem

**The First Canal.** In the first canal we have a gate and a series of server blocks that represent the amount of time that is necessary to pass through the canal, depending on the direction. The opening of the gate is controlled by the cycler subsystem.

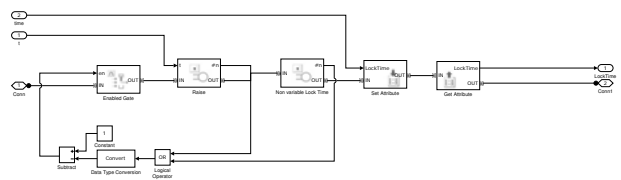

Figure 6: Lock Subsystem

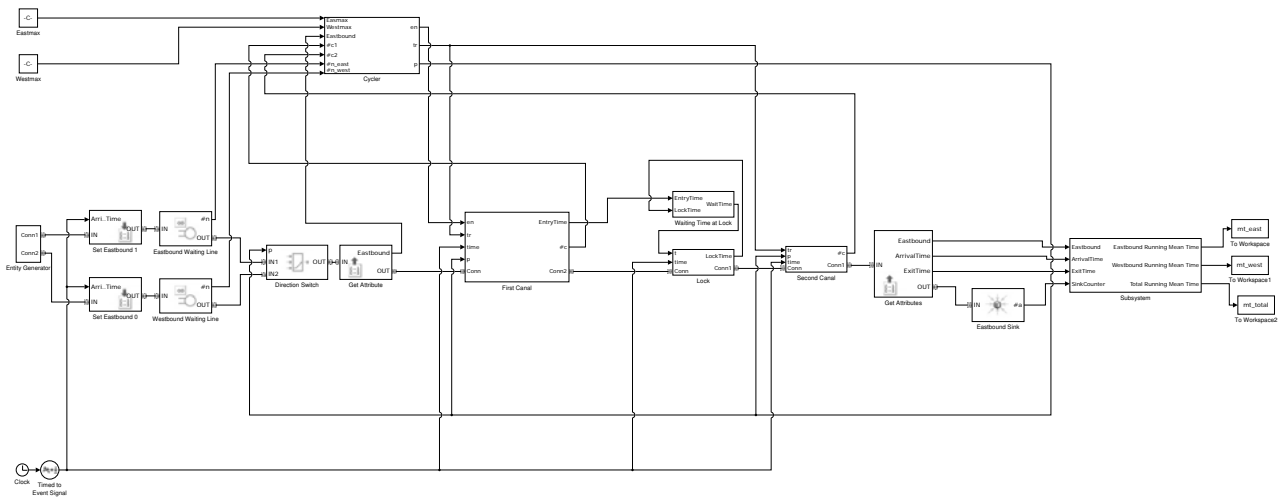

Figure 3: Overview of the Model

**The Lock.** The next subsystem is the lock itself, which also consists of gates and servers. We separated the time spent in the lock into two parts, the non-variable part and the variable part. We block the entrance into the lock with an enabled gate that only allows entities in, if the system is empty. Then follows a server block, that represents the variable part of the time spent in the lock. To calculate the service time in the server block we pass along the time the previous ship left the lock.

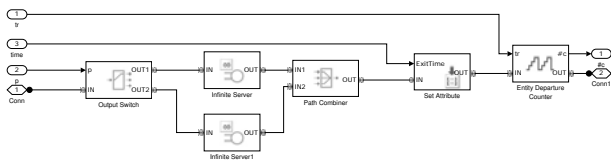

Figure 7: Second Canal Subsystem

**The Second Canal.** Now follows the second canal which is just a series of servers, with a fixed service time, dependant on the direction of the ship entities.

**Exit.** Before leaving the system, the transit time of the entity, as well as a moving mean are calculated. This is necessary for the Model validation and the variance reduction experiments.

### 2.1 Model validation

The validation of the Model was done with given datasets, which, in contrast to the later variance reduc-

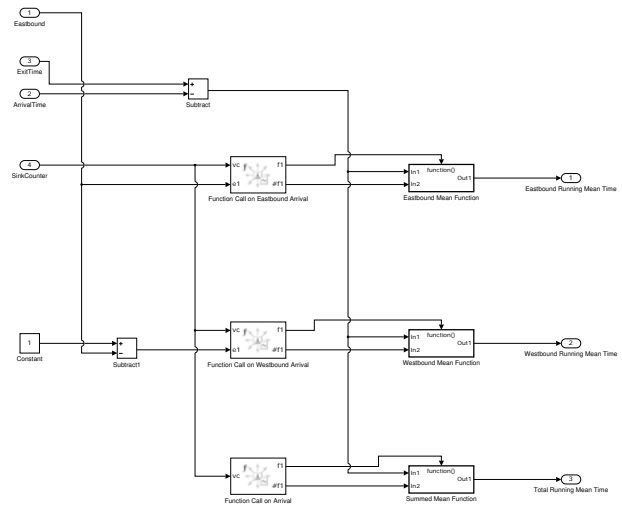

Figure 8: Exit Subsystem

tion experiments, also included cases with multiple simultaneously arriving ships.

## 3 Variance reduction experiments

For the variance reduction experiments, the arrival times of the ships were pre-calculated. While the interval between the arrival of two ships is exponentially distributed with a mean of 75, the first ship arrives at an uniformly distributed time, with a mean time of 15 minutes for the eastbound, and ten minutes for the westbound ship. For this, the pseudo random number

generator of matlab was used. The end time was set to 14400 minutes to simulate a ten day period and 100 independent replications were conducted. The maximum number of ships for a full cycle was set to five in both directions. For better insight, the whole simulation was repeated two more times. All the following numbers were calculated with Gnumeric 1.12.17.

	Mean	90% CI	$\sigma^2$
<b>Run 1</b>	511,17	36,17	219,88
<b>Run 2</b>	472,25	37,49	227,93
<b>Run 3</b>	520,96	37,74	229,47

**Table 1:** Three independent runs of the simulation

The use of the antithetic random variates variance-reduction methodology brought a significant contraction of the confidence interval and  $\sigma^2$ .

	Mean	90% CI	$\sigma^2$
<b>Run 1</b>	547,88	30,19	129,77
<b>Run 2</b>	536,81	31,62	135,93
<b>Run 3</b>	553,61	31,52	135,50

**Table 2:** Three independent runs of the simulation using the ARV variance-reduction method.

The next experiment compared the mean transit times, when the cyclelength is set to six, to the cyclelength of five in both directions. We considered the null hypothesis that the expected transit time for five-ship-cycles is less than or equal than six-ship-cycles. 50 replications for the first case and 50 for the second case were done and the mean times subtracted. A negative number means that the six-ship-cycle took longer than the 5-ship-cycle.

	Difference	90% CI	$\sigma^2$
<b>Run 1</b>	72,66	73,85	317,48
<b>Run 2</b>	137,99	76,92	330,69
<b>Run 3</b>	39,40	67,86	291,73

**Table 3:** The difference between Eastmax and Westmax set to six or five.

Based on the result of these runs we cannot reject the null hypothesis. But with the use of common random numbers (CRNs), we get a different conclusion.

	Difference	90% CI	$\sigma^2$
<b>Run 1</b>	67,50	7,05	30,33
<b>Run 2</b>	69,52	8,52	36,64
<b>Run 3</b>	59,20	8,34	35,87

**Table 4:** The difference between Eastmax and Westmax set to six or five with CRNs.

As we can see, the intervals are strictly positive and thus we can safely reject the null hypothesis. The reduction of the confidence interval is not surprising, but still remarkable.

## References

- [1] Schriber T J. Comparison 8: Canal-and-Lock System. *SNE*. 1995; 6(1): 29–31.